

JUKI®

LU-2200N Series

High-speed, Unison-feed, Lockstitch Machine
with Vertical-axis Large Hook and Automatic Thread Trimmer

high speed

powerful



high performance

LU-2200N Series

Capabilities for sewing car seats have been significantly improved.

Efficiency of feed and sewing capabilities for supporting sewing performance at a higher speed of 3,500rpm



LU-2210N-7

High-speed, 1-needle, Unison-feed, Lockstitch Machine with Vertical-axis Large Hook and Automatic Thread Trimmer

LU-2210N-7 **1.6 fold-capacity hook**

LU-2210W-7 **Double-capacity hook**

The machine demonstrates outstanding performance when sewing heavy materials, with its "high-quality consistent sewing capabilities", as well as with its remarkably powerful feed.



LU-2260N-7

High-speed, 2-needle, Unison-feed, Lockstitch Machine with Vertical-axis Large Hook and Automatic Thread Trimmer

LU-2260N-7 **1.6 fold-capacity hook**

LU-2260W-7 **Double-capacity hook**

The machine is the standard type 2-needle machine, which is essential for topstitching processes. As with the aforementioned 1-needle machine, the standard 2-needle machine has an outstanding high-speed capability and promises consistent sewing performance.

3,500 LU-2200N Series rpm

Higher lift of the presser foot

- The machine is provided as standard with a pneumatic auto-lifter.
- The high, 16mm presser foot lift enables easy material handling.

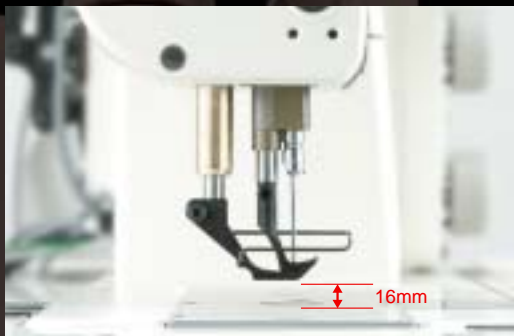

The walking foot and presser foot's alternating vertical movement can be set and changed with ease.

- The vertical strokes of the presser foot and walking foot (alternating vertical movement) can be easily changed using a large dial mounted on the top surface of the machine head.
- In addition the sewing speed is automatically adjusted with the set value. With this feature, ideal sewing conditions are maintained at all times.



The machine promises outstanding adaptability and ease of use with its full-fledged functions.

The highly efficient vertical-axis 1.6 fold-capacity hook is provided as standard.

- With the adoption of this vertical-axis 1.6 fold-capacity hook, the frequency of bobbin thread winding is reduced, promising sewing work of increased efficiency.

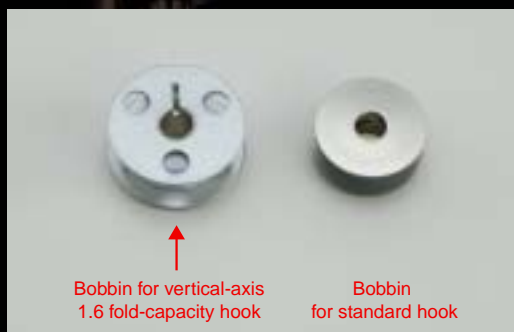

Instantaneous change-over device for the alternate vertical movement amount (DL device) is provided as standard.

- The alternate vertical movement amount can be instantaneously maximized in a process for sewing a hard-to-feed part of material, such as a multilayered part, finishing with beautiful seams free from stitch gathering.
- The machine is provided with both a hand switch and knee switch.

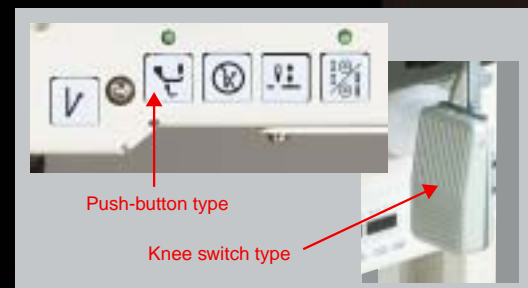

High-speed, 1-needle, Unison-feed, Lockstitch Machine with Vertical-axis Large Hook and Automatic Thread Trimmer

LU-2212N-7 1.6 fold-capacity hook / 2-pitch dial type

One of two different stitch lengths can be selected according to the application. The stitch length can be instantaneously changed over by pressing the stitch selector switch mounted on the lower part of the machine arm.

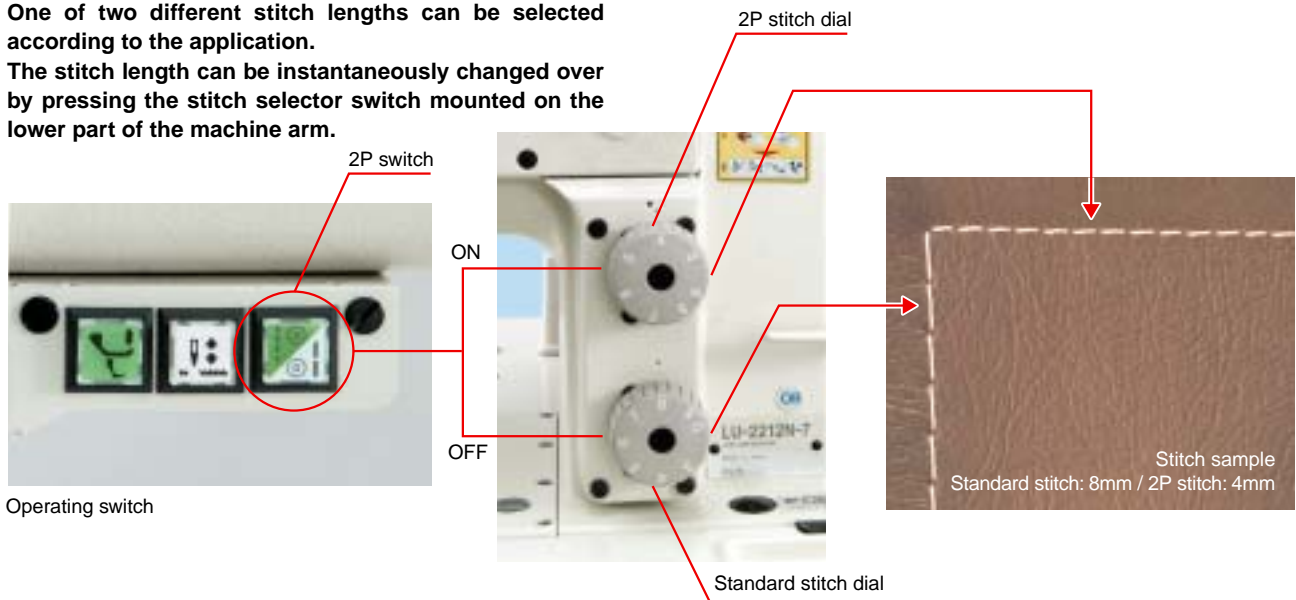

High-speed, 1-needle, Unison-feed, Lockstitch Machine with Vertical-axis Large Hook and Automatic Thread Trimmer

LU-2220N-7 1.6 fold-capacity hook / 2-pitch dial / Shorter thread remaining type

Thread nipping work required at the beginning and end of sewing is reduced. This is a high-performance machine which contributes to both increased productivity and improved quality for sewing car seats. Frequency of the use of scissors by the operator is reduced, thereby helping prevent the material from being damaged.

[Comparison of the remaining thread length]

Upper side: LU-2210N-7 / Lower side: LU-2220N-7

Right side of the material at the beginning of sewing



The needle thread does not remain on the right side of the material.

Wrong side of the material at the end of sewing

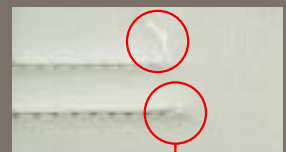

Remaining-thread length: 5mm



Operating switch



Needle thread clamping at the beginning of sewing can be turned ON/OFF.

The thread trimming mechanism has been totally redesigned to shorten the length of thread remaining on the material at the end of sewing down to 5 mm.















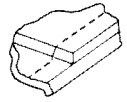

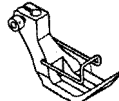
ATTACHMENTS

| Description | Part No. |
|--------------------------------------|--------------|
| Suspended ruler (asm.) H152 | MAH-152010A0 |
| Suspended ruler mounting base (asm.) | 107-35868 |

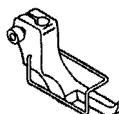
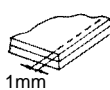
*Suspended ruler mounting base (asm.) is required to mount the suspended ruler.

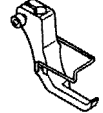
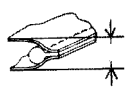
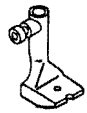
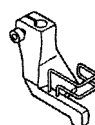
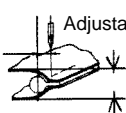
INTERCHANGEABLE GAUGE PARTS

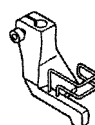
[LU-2210N-7 || LU-2210W-7 || LU-2212N-7 || LU-2220N-7]

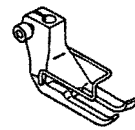
| Application | | Walking foot | | Presser foot | |
|---|--|--------------|---|---|--|
| Standard  | | A | Standard |  | A Standard 107-12552  |
| | | | | | K Standard (pressing face is reduced) 107-58456  |
| | | | | | B For material with overlapped section 107-12651  |
| For material with overlapped section Allows the smooth feed of multi-layered portions of the material  | | | 107-11653 | | |
| For light-weight sponge Used for resilient materials including sponge  | | | | | C For urethane 107-12750  |
| For heavy-weight sponge Used for more resilient materials Thick  | | B | For urethane 107-11752  | | |
| Right single-sided presser Used for sewing material edges  1mm | | C | Right single-sided 107-11851  | D Right single-sided 107-12859  | |
| Left single-sided presser Used for sewing material edges  1mm | | D | Left single-sided 107-11950  | E Left single-sided 107-12958  | |
| For piping Used for the general piping process  | | E ~ H | For piping 3 107-45354 4 107-45453 5 107-45552 6 107-45651  | F ~ J For piping  | |
| For piping The position of the needle can be adjusted according to the pipe to be sewn Adjustable  | | J ~ M | Adjustable presser for piping 3 107-46352 4 107-46451 5 107-46550 6 107-46659  | 3 107-47350 4 107-47459 5 107-47558 6 107-47657  | |
| Wide type To be used when a sewing product cannot be smoothly fed  | | | (special order) 107-12057  | (special order) 107-13055  | |

INTERCHANGEABLE GAUGE PARTS

●Throat plate

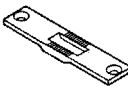
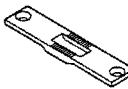
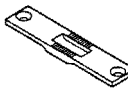



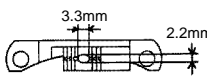
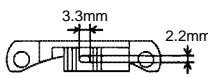
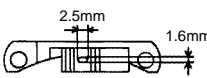
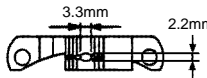
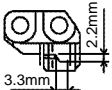
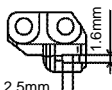
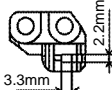

| For LU-2210N-7 / 2212N-7 | | For LU-2220N-7* |
|---|---|---|
|  |  |  |
| 107-01704 | 107-02009 | 400-58071 |
| Standard | Wide type (special order) | Standard |

*Throat plate (400-58071) for the LU-2220N-7 is also applicable to the LU-2210N-7/LU2212N-7.

●Feed dog

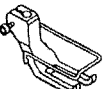
| For LU-2210N-7 / 2212N-7 | | | |
|---|---|---|---|
|  |  |  |  |
| 107-17106 | 107-17205 | 107-17304 | 107-39001 |
| S Standard (thread groove width: 1.0mm) | A Without groove (To be used if the needle thread and bobbin thread do not intertwine with each other at the beginning of sewing) | B For thin thread (thread groove width: 1.0mm) | Wide type (special order) |
| For LU-2220N-7 | | | |
|  |  |  | |
| 400-58070 | 400-64353 | 400-62827 | |
| S Standard (thread groove width: 1.0mm) | B For thin thread (thread groove width: 1.0mm) | C For thick thread (thread groove width: 1.9mm) | |

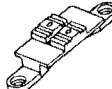
[LU-2260N-7 [LU-2260W-7]

| Needle gauge | Gauge* set No. | Needle clamp | Presser foot | Walking foot | Throat plate | Feed dog | Slide plate* | |
|---|-------------------|---|---|---|--|---|---|-----------|
| | | | | | | | Left | Right |
|  | |  |  |  |  |  |  | |
| 6mm | 107-84650 | 107-77654 | 107-81656 | 107-83157 | 107-84601 | 107-80104 | 107-86309 | 107-01803 |
| 8mm | 107-84759 | 107-77753 | 107-81755 | 107-83256 | 107-84700 | 107-80203 | | |
| 10mm (standard) | 107-84858 | 107-77852 | 107-81755 | 107-83355 | 107-84809 | 107-80302 | 107-86408 | 107-86002 |
| 12mm | 107-84957 | 107-77951 | 107-80401 | 107-83454 | 107-84908 | 107-80401 | | |
| 20mm | 107-85350 | 107-78355 | 107-82357 | 107-83850 | 107-85301 | 107-80807 | 107-86507 | 107-86101 |

Note) Applicable to gauges "4 mm to 36 mm" (LU-2260N-7) and "4 mm to 30 mm" (LU-2260W-7).

Any gauges other than the forementioned are available through special order.

*The right and left slide plates are not included in the parts represented by the gauge set number.

WHEN YOU PLACE ORDERS

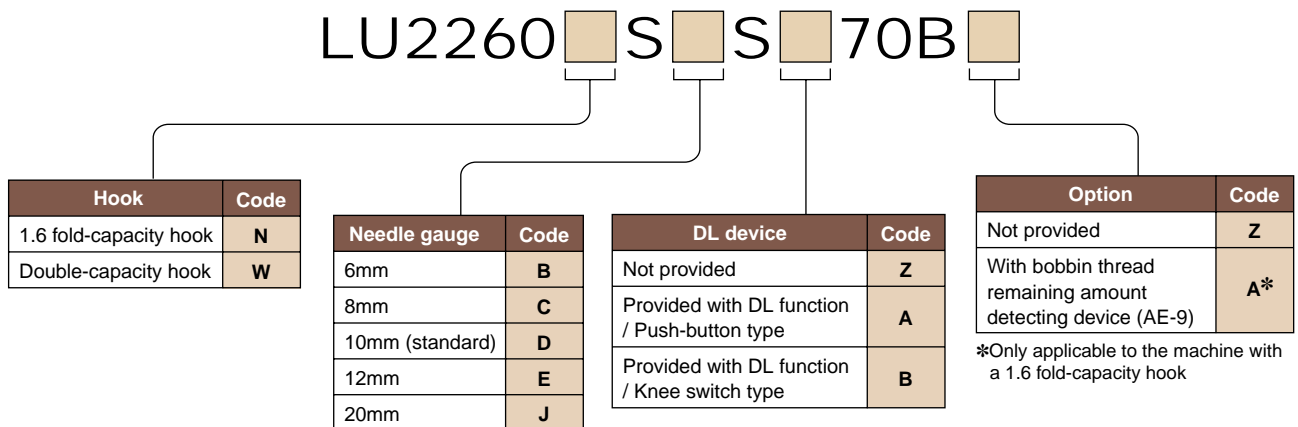
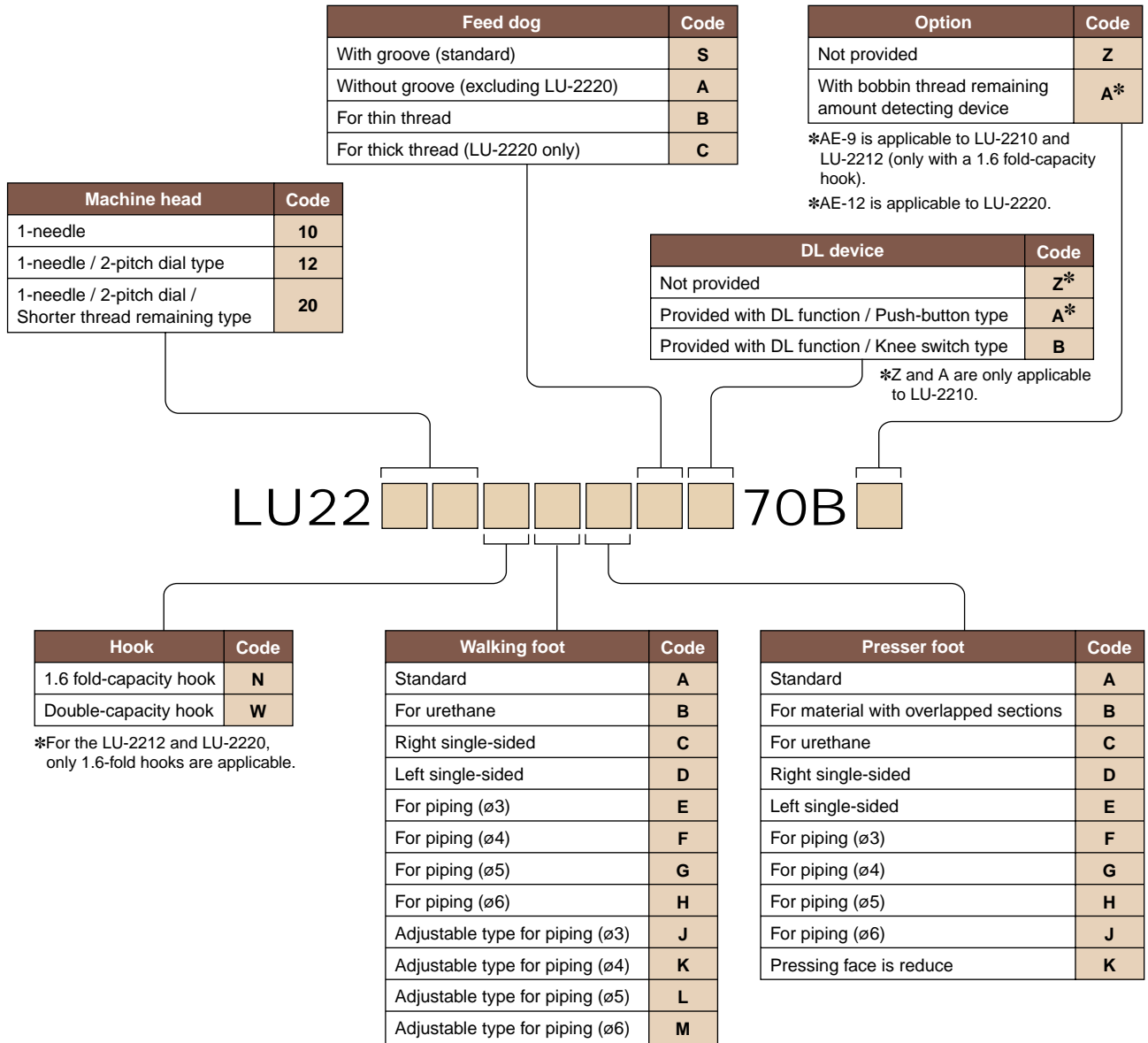

SPECIFICATIONS

| Model name | LU-2210N-7 LU-2210W-7 | LU-2212N-7 | LU-2220N-7 | LU-2260N-7 LU-2260W-7 |
|-------------------------------------|--|---|--|--|
| | 1-needle | 1-needle / 2-pitch dial type | 1-needle / 2-pitch dial / Shorter thread remaining type | 2-needle |
| Max. sewing speed | 3,500rpm | | | |
| Max. stitch length | 9mm (forward/backward) | | | 6mm (forward/backward) |
| Needle bar stroke | 33.8mm | | | |
| Max. lift of the presser foot | Auto: 16mm, By hand: 9mm | | | |
| Alternating vertical movement | 1mm ~ 6.5mm (by dial) | | | |
| Thread take-up | Link type | | | |
| Hook | N: Vertical-axis 1.6 fold-capacity hook W: Vertical-axis double-capacity hook | N: Vertical-axis 1.6 fold-capacity hook | | N: Vertical-axis 1.6 fold-capacity hook W: Vertical-axis double-capacity hook |
| Needle | 134 x 35R (Nm140) Nm110 ~ Nm160 | | | |
| Thread | #30 ~ #4, B46 ~ B138, Nm60/3 ~ 20/3 | | | #20 ~ #5, B64 ~ B138, Nm40/3 ~ 20/3 |
| Distance from needle to machine arm | 263.5mm | | | |
| Lubrication | Automatic | | | |
| Bobbin thread winder | Built on the machine head | | | |
| Safety mechanism | Provided as standard | | | |
| Automatic reverse feed function | Provided as standard | | | |
| Auto-lifter | Provided as standard (pneumatic auto-lifter) | | | |
| Compressed air | 0.5MPa | | | |
| Air consumption | 0.763d ^m /min (ANR) | 1.078d ^m /min (ANR) | 1.337d ^m /min (ANR) | 0.736d ^m /min (ANR) |
| Weight of the machine head | 55kg | | | 58kg |
| Power requirement | Single-phase 100 ~ 120V, 200 ~ 240V 3-phase 200 ~ 240V | | | |
| Power consumption | 425VA | | | |